

PHOENICS News



Table of Contents

Title	Page
PHOENICS 2019	2
Ventilation of the Spanish Parliament Building	9
News from CHAM Agents	11
News from CHAM	12



What's New in PHOENICS 2019

PHOENICS-2019 Introduction

CHAM has released the 2019 version of PHOENICS. Professor Spalding's team at CHAM in Wimbledon Village continue his work and create annually updated versions of the software which has been available as a commercially independent code since 1981. The annual releases incorporate new features required by Users, or suggested by advances in technology and improvements responding to the environmental issues current today.

PHOENICS is applied to wide ranging applications in the general environment, the built environment, sewage disposal, green energy and industry. The software simulates scenarios involving fluid flow, heat and mass transfer, chemical reactions and combustion.

PHOENICS-2019 contains new, and enhanced, features which enable it to model existing and new scenarios with greater efficiency and speed.

Upgrades to the Earth Solver

Additional Linear Equation Solvers

Many additional linear-equation solvers and pre-conditioners have been incorporated, including several from the HYPRE suite. The new solvers, especially those from HYPRE, are less affected by grid refinement, and should prove superior for fine grids, especially when many blocked cells are present.

Use of the HYPRE BoomerAMG Solver

This shows the effect of one of the new solvers. The geometry is flow in an L-shaped duct:

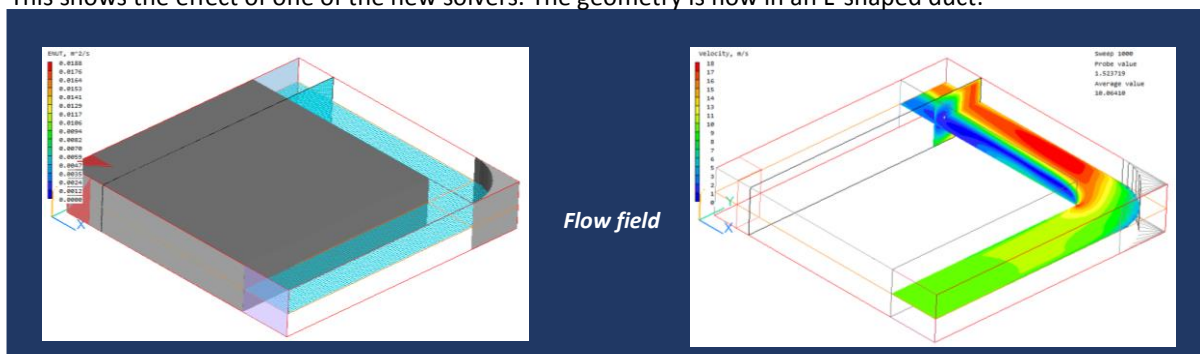

The blockage is participating, and the red in the corner is a fixed temperature region. The overall grid is $125 \times 125 \times 50$. The grid in the open part of the duct is 50×50 , and the blocked part is $75 \times 75 \times 50$. The solution is much as one would expect:

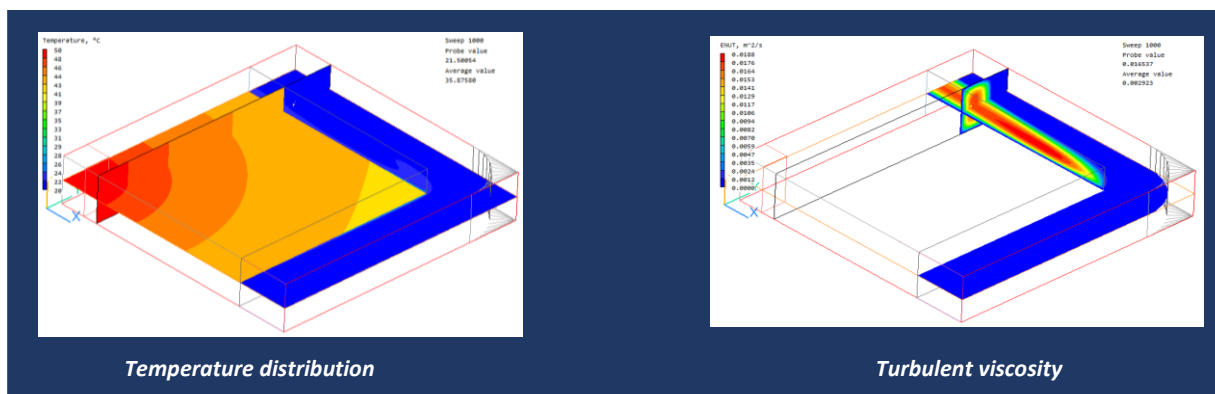

For further information see www.cham.co.uk/phoenics/d_polis/d_enc/solvers.htm.

New Boundary Conditions for Non-Participating Blockages

It is now possible to set a range of heat and scalar boundary conditions on the outer surface of a faceted non-participating blockage (ie one using material 198 and which does not use a geometry starting 'cube').

When the IMMERSOL or P1-T3 radiation models are active, the 'Adiabatic' condition is implemented in the same way as at adiabatic plates - the sum of convective and radiative fluxes is zero rather than each flux being zero as was previously the case. A surface temperature (stored in TWALL) is deduced, and used as the thermal and radiative boundary condition. The following images show Temperature and T3 contours for flow past two adiabatic blocks, first from PHOENICS 2018 and then from PHOENICS 2019.

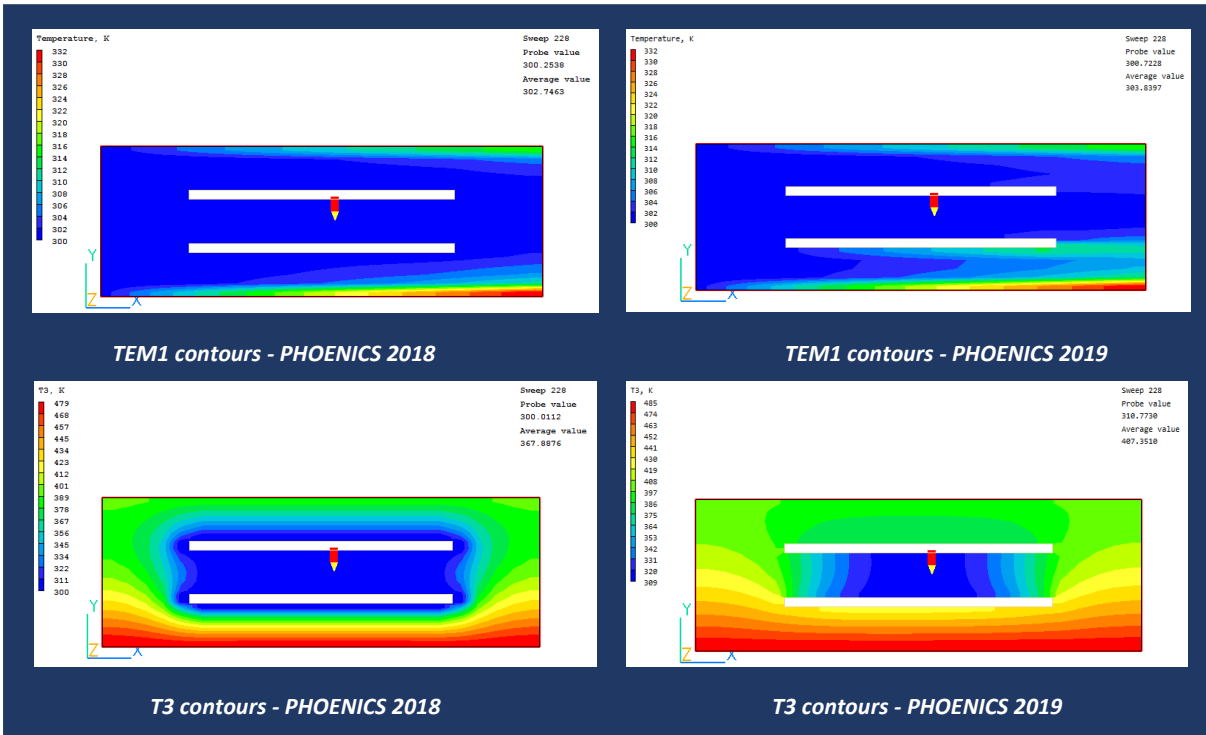

Extensions to Volume-Of-Fluid (VOF)

THINC-WLIC is implemented in PHOENICS as an additional VOF method. THINC (Tangent of Hyperbola for Interface Capturing) uses hyperbolic tangent functions to devise a conservative, oscillation-less, smearing-less scheme showing competitive accuracy compared to most existing methods with no geometry reconstruction. Multi-dimensional computing is conducted by the WLIC (Weighted Line Interface Calculation) method.

All VOF methods can now solve temperature-dependent cases, with proper treatment of temperature in each phase and in any immersed solids. The following images show a drop of hot fluid falling over a solid obstacle:

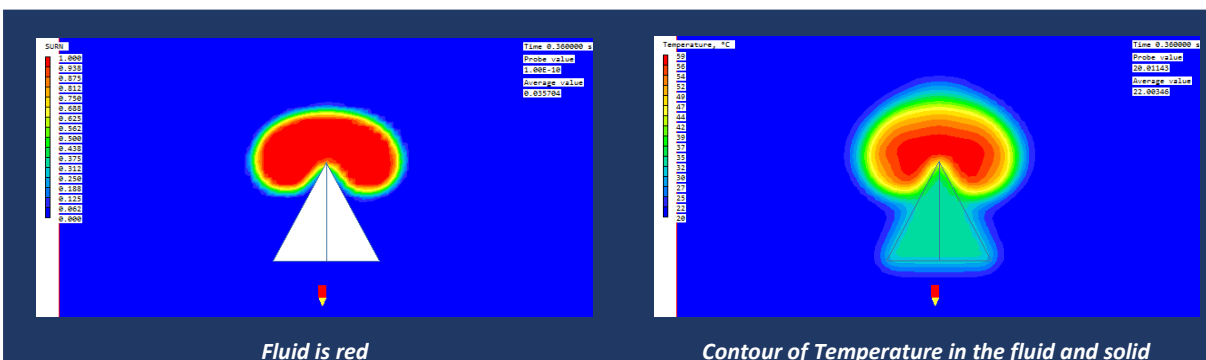

Options have been added to make the surface tension a linear function of temperature, or to use the Langmuir equation of state which includes a scalar as well as the temperature. A constant static contact angle can be specified to model wall adhesion effects.

PARSOL Upgrade

In PHOENICS 2019, SPARSOL remains the default cut-cell method. The alternative PARSOL method has been substantially rewritten, and the quality of detection has been improved. The next images show the property-marker PRPS fields produced for flow in a channel carved from a solid block (Library case 627) by PHOENICS 2018 and PHOENICS 2019. The new PRPS fields are much smoother and fit the geometry better.

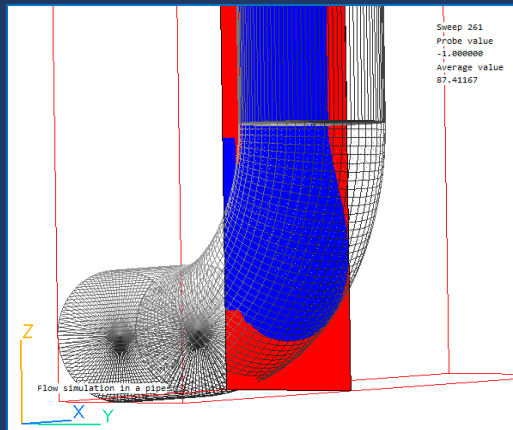

PHOENICS 2018

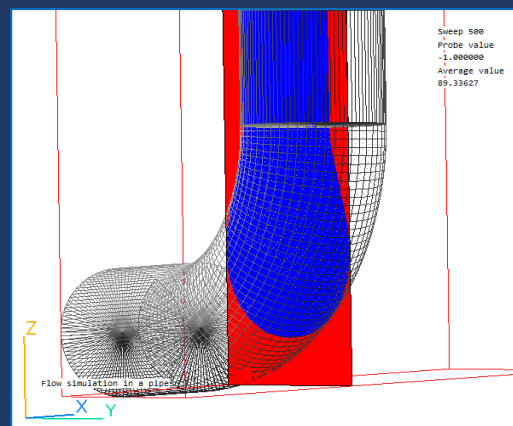

PHOENICS 2019

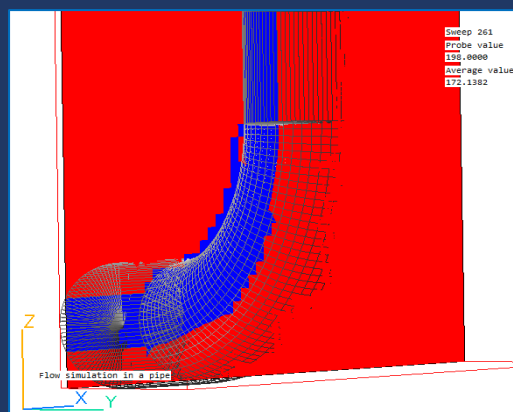

PHOENICS 2018

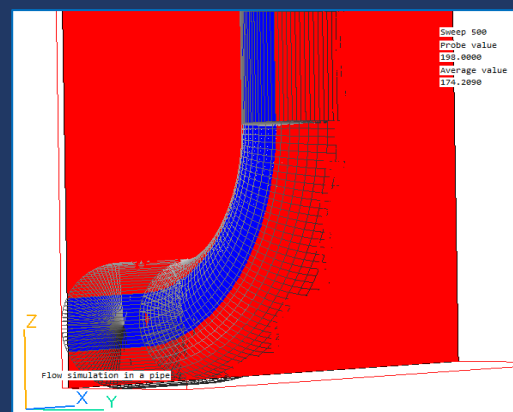

PHOENICS 2019

Upgrade to solar illumination model



The shading algorithm used by the SUN object has been rewritten and is considerably faster. The shading shown in this image was calculated in under a minute.

The illumination is calculated for each cell in the air space, not just on object surfaces, which would have been impractical using the previous method.

SPARSOL - Angled-In Objects

The treatment of ANGLED-IN objects by SPARSOL has been improved, as shown by the following images which

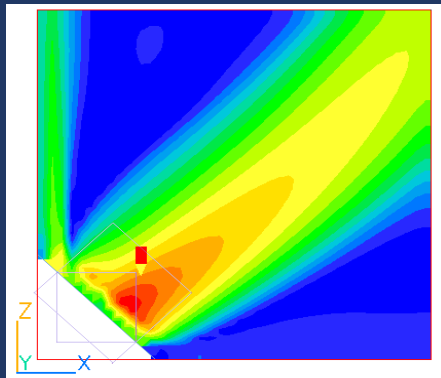

PHOENICS 2018

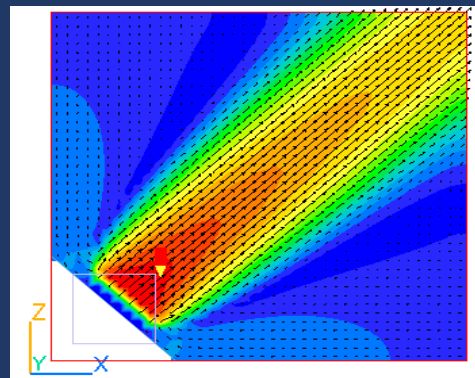

PHOENICS 2019

Improvements to the Editor

Simplified menus

show an ANGLED-IN acting on the surface of a wedge blockage in PHOENICS 2018 and in PHOENICS 2019.

VR-Editor Main Menu panels operate in two modes, (show) Less and (show) More. (Show) Less is as per previous versions in that all available options are presented. The (show) More mode displays only the most commonly used options. The mode is recorded in the Q1 file saved at the end of a session for use next time the Q1 is loaded.

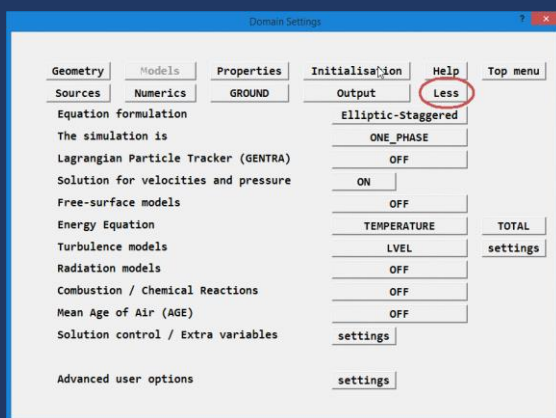

Full Menu – 'Less' changes dialogue to that shown right

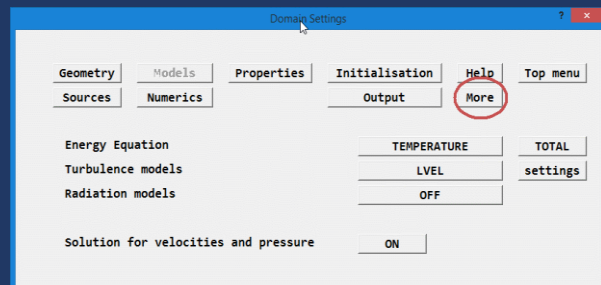

Reduced menu - pressing 'More' restores full menu shown left

Menu items are in English instead of PHOENICS Input language reducing use of 'jargon' or command language:

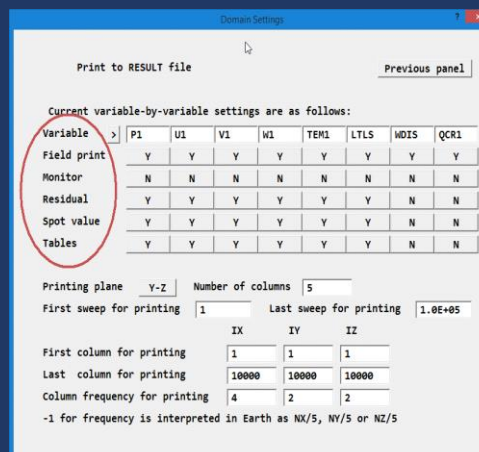

Menu selection of solver / pre-conditioner pairs

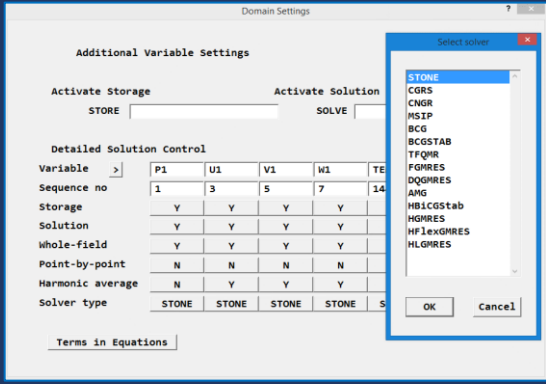

Selection of Solvers

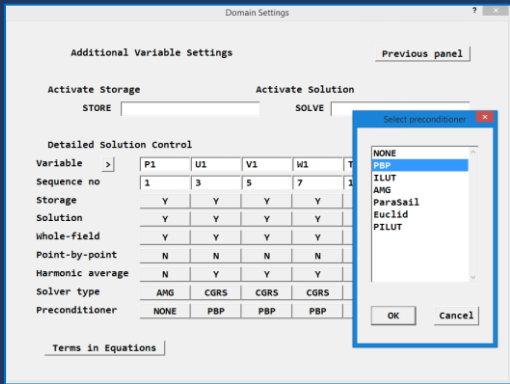

Selection of Preconditioners

GUIs for service programs phisum, phidiff and pho2vtk

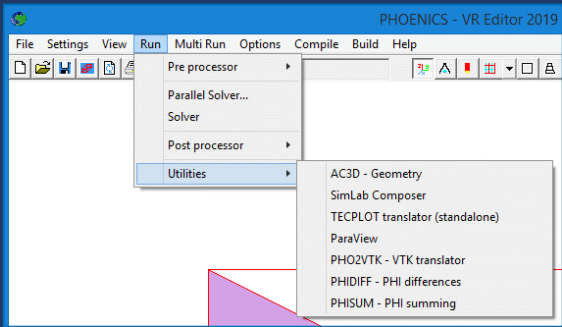

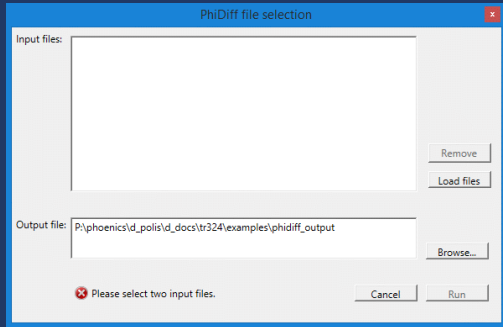

These are accessed from Main Menu - Run – Utilities. To produce interfaces like this (for PHIDIFF) this utility subtracts the field values in file 2 from those in file 1 and creates a new file containing the differences.

Extend GUI for new P1-T3 radiation model

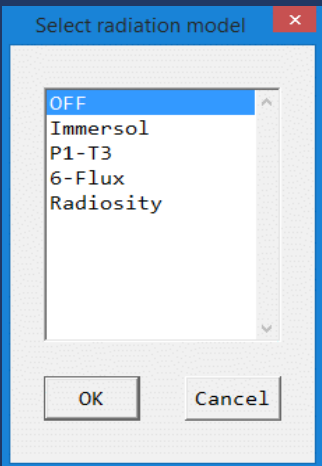

The new P1-T3 radiation model is in the list of available radiation models under Main menu - Models - Radiation

Calculation of Q-Criterion and Vorticity

The Main Menu-Output-Derived Variables panel allows activation of calculation and storage of the Q-criterion and Vorticity. The images show Q-criterion and Vorticity contours during vortex shedding from a square block:

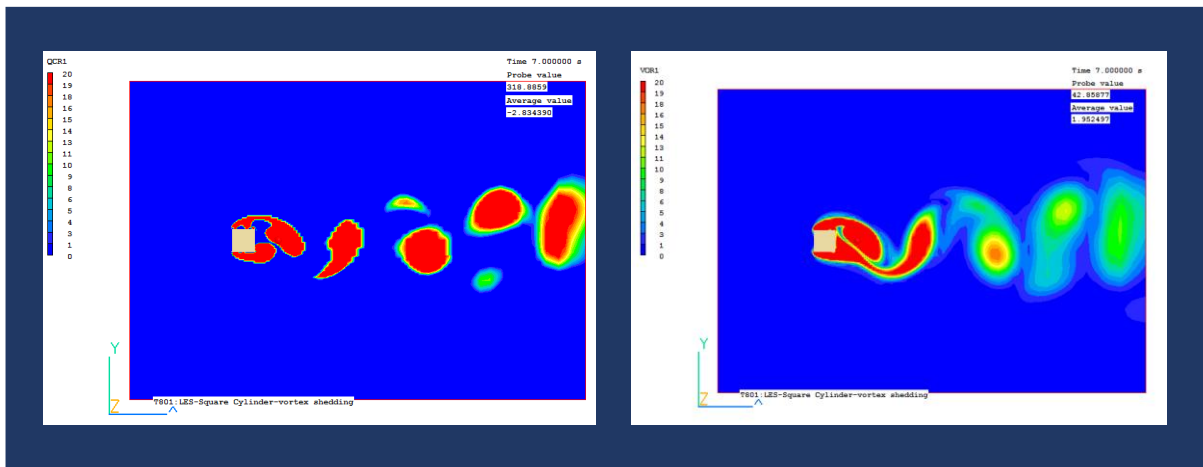

Improvement to Viewer

Iso – surface Upgrade

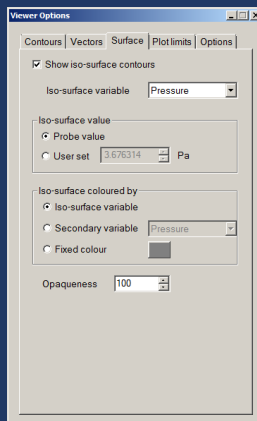

The iso-surface contour feature has been extended to allow an iso-surface of one variable to be coloured by the contour map of another. This is activated from the 'Surface' tab of the 'Viewer Options' dialog.

The 'secondary' variable can be any SOLVED or STORED variable. The image below shows an iso-surface of P1 coloured by Velocity: The 'Fill', 'Lines' and 'Fill and lines' options on the 'Contour' tab also operate on the iso-surface contour map.

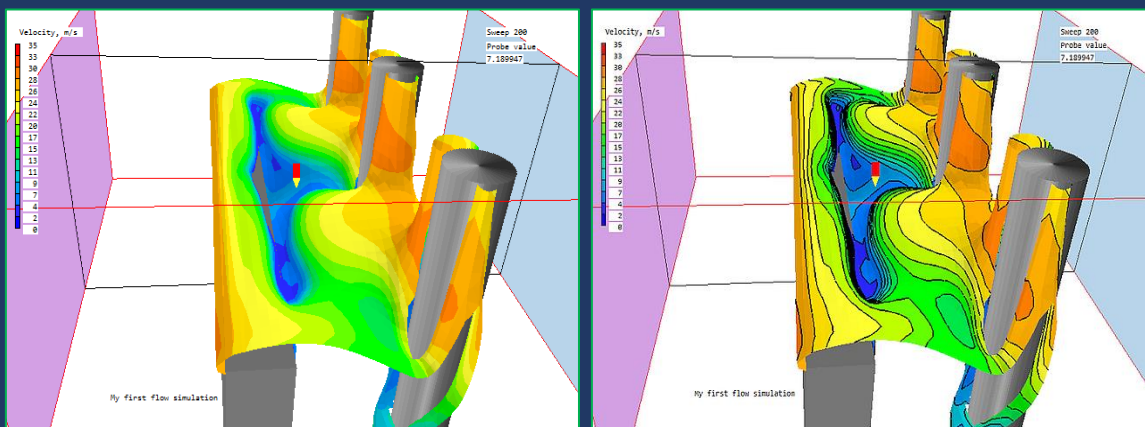

Choice of colour maps

Several pre-set colour maps have been made available. These are selected from the 'Update palette' button on the 'Contours' tab of the Viewer Options dialog. The dialog allows one of several pre-set colour palettes to be loaded and there is a 'Custom option whereby users can set, and save, each colour in the palette.

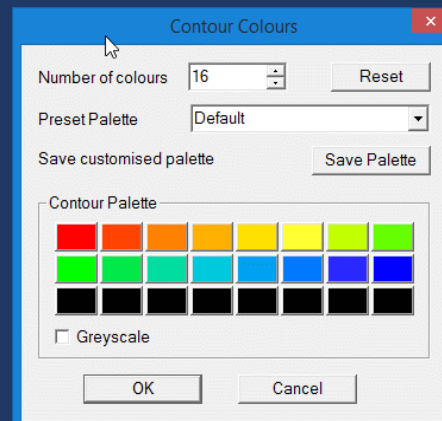

Improved surface contours

To plot contours on the surface of an object, that surface must be offset slightly from the actual surface of the body. The algorithm for offsetting the plotting surface has been improved, leading to better surface contours.

The image shows surface contours not matching the in-plane contours:

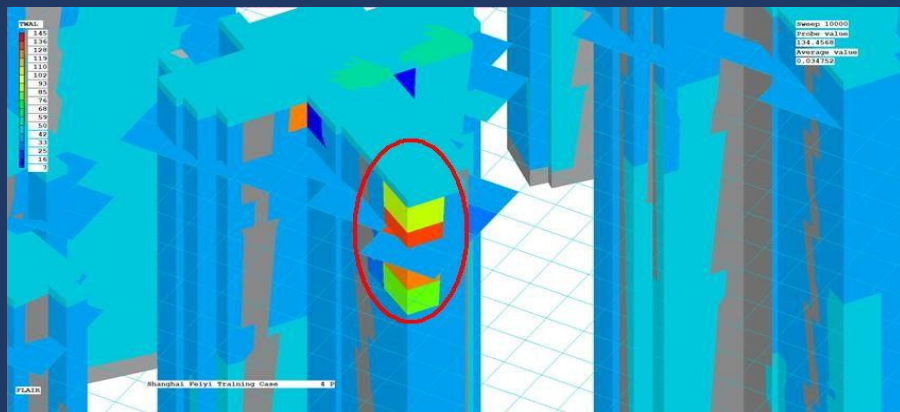

The image shows the same plot after correction. The misalignment is much reduced.

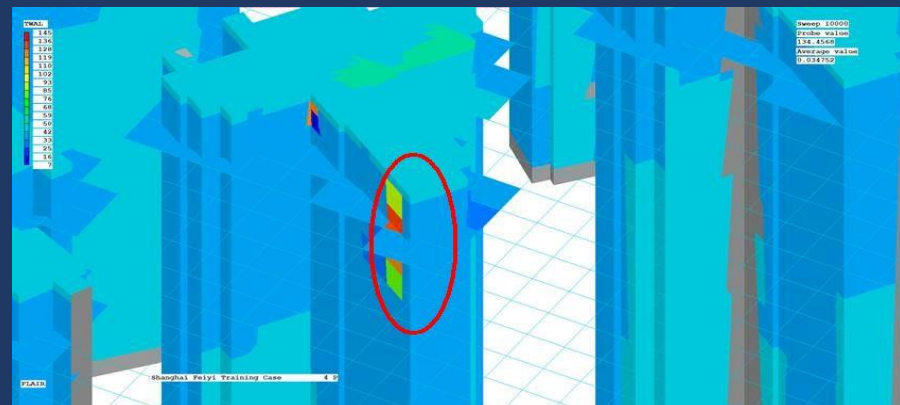

Stopping an Animation

Users reported that it can be difficult to stop an animation early especially if solution files are large and it takes a long time to read each file. The mechanism to check for an interrupt (pressing the animation toggle  again) has been rewritten to make the process more reliable. In addition, if VR-Viewer finds a file called 'stopit' or 'stopit.txt' in the working folder during an animation, it will stop the animation and delete the file. Other changes can be viewed on www.cham.co.uk.

Ventilation of the Spanish Parliament Building

A PHOENICS-Flair application undertaken on behalf of Tayra SL by Krantz GmbH



El Congreso de los Diputados



The Hall during a parliamentary plenary session

The **Congreso de los Diputados** is the seat of the lower house of the Spanish Parliament located in the **Palacio de las Cortes de España**. Built in 1843, it represents one of the finest examples of late-neoclassical architecture to be found in Madrid. The following describes the use of PHOENICS - by Krantz GmbH for Tayra SL – to model ventilation design for the parliament building.

The seating layout caters for one person/m² with a monitor in front of each seat. The air diffusion equipment was supplied by Krantz following laboratory tests coupled with CFD simulations. CFD and laboratory tests were compared to validate their accuracy. Tayra designed the system layout, supervised the installation and undertook their own field tests in situ to check the CFD predictions. Physical measurements confirmed that the ventilation system performance met expectation.

The ventilation system uses three types of diffuser: whirl diffusers for the main chamber; slot diffusers for the Galeria and Krantz Opticlean diffusers under the Galeria. It was not practical to capture the detail of the diffuser

operation in a large-scale CFD simulation. Hence,

“substitution models” were used having the same flow characteristics as the physical diffusers. The whirl diffusers produce a highly turbulent air flow with increased induction rate. The jet is characterized by its throw and its droop, the latter being an effect of buoyancy based on the difference in temperature between the supply air and the ambient air within the space. Its substitution model compared favorably with temperature and velocity values from laboratory tests. The next plot shows the laboratory test results for th diffuser WL3.

WL3 at $V_0 = 868 \text{ m}^3/\text{h}$ and $\Delta T = 10 \text{ }^\circ\text{C}$

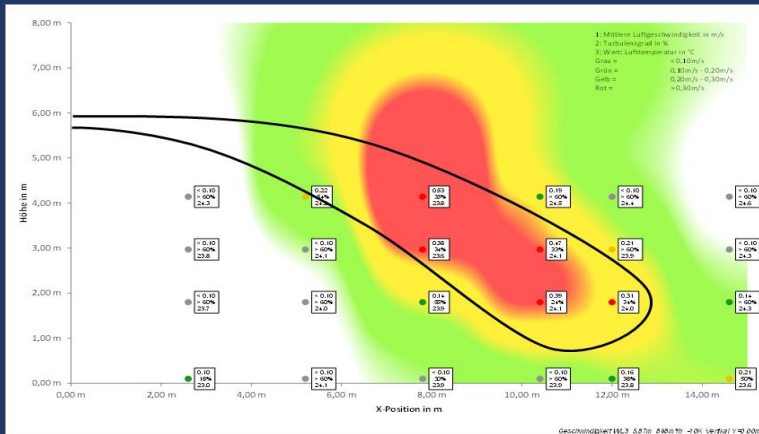

Comparison at a selected location ($x = 10.3 \text{ m}$, $H = 3 \text{ m}$) shows the following values:

	<i>Lab test</i>	<i>Simulation model</i>
Velocity	$u = 0.47 \text{ m/s}$	$u = 0.48 \text{ m/s}$
Temperature	$T = 24.1 \text{ }^\circ\text{C}$	$T = 24.0 \text{ }^\circ\text{C}$

3D Geometry Model

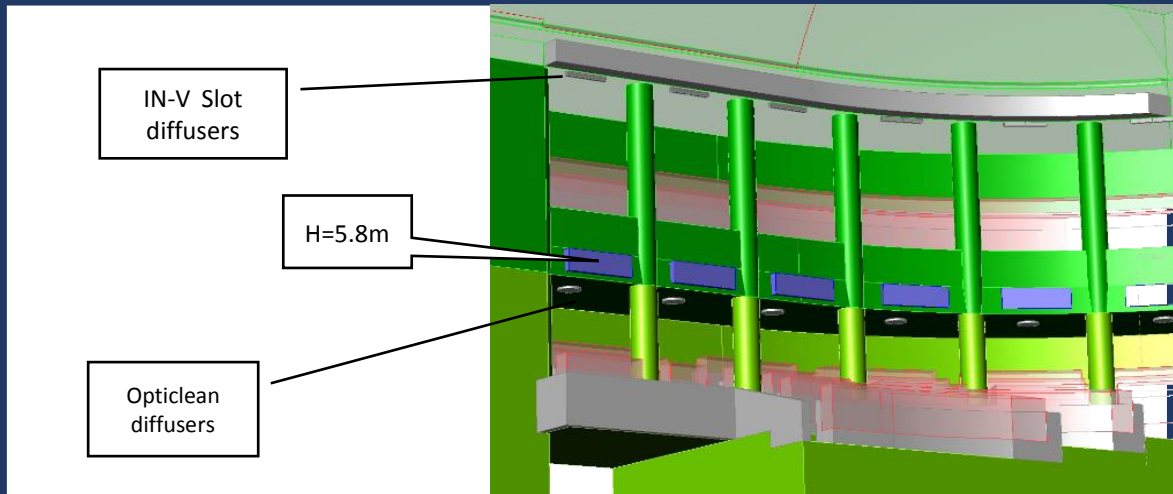

Results - Temperature profiles

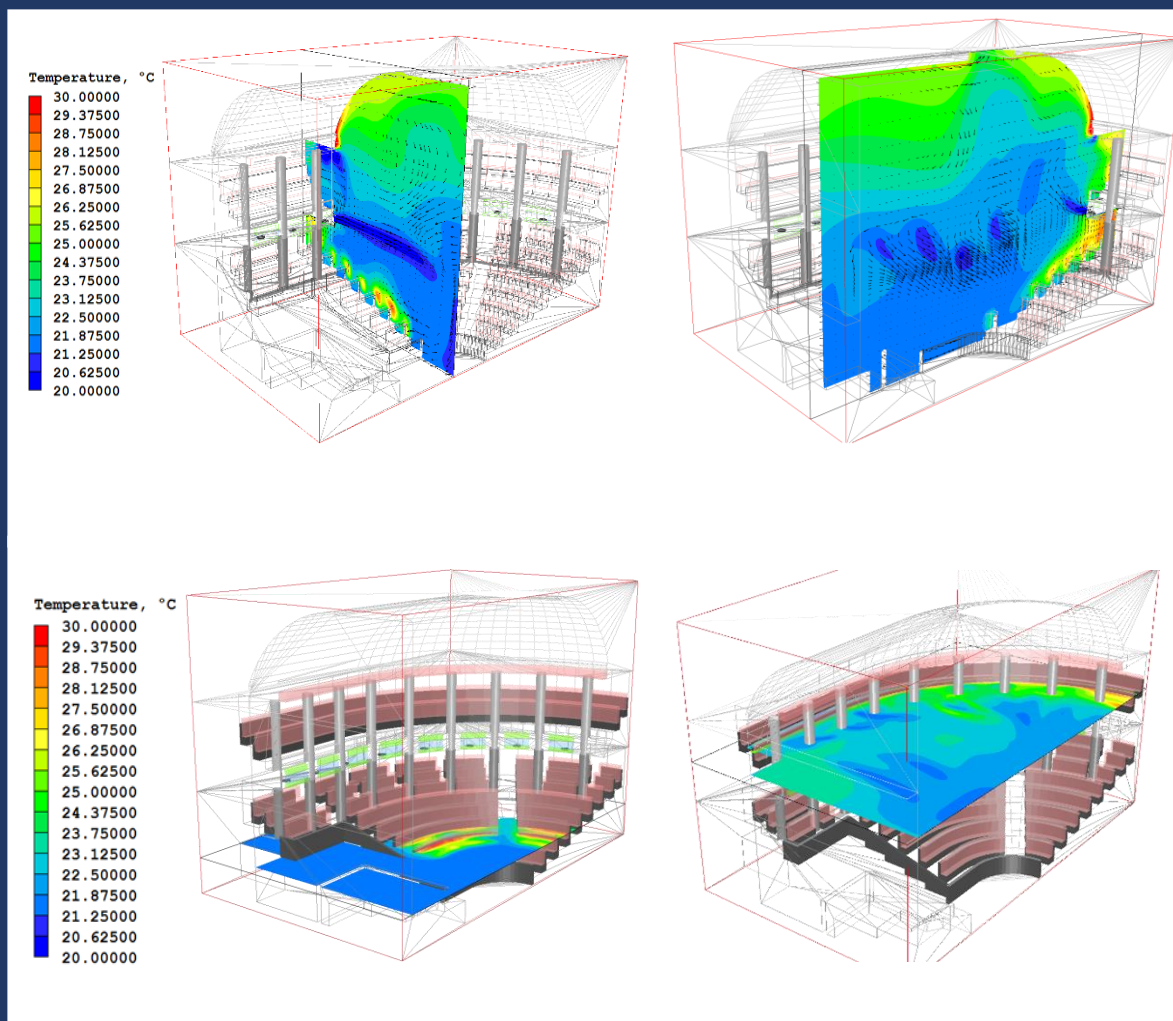

Tarya's independent investigation confirmed the similarity between the excellent CFD analysis output from Krantz and their field results.

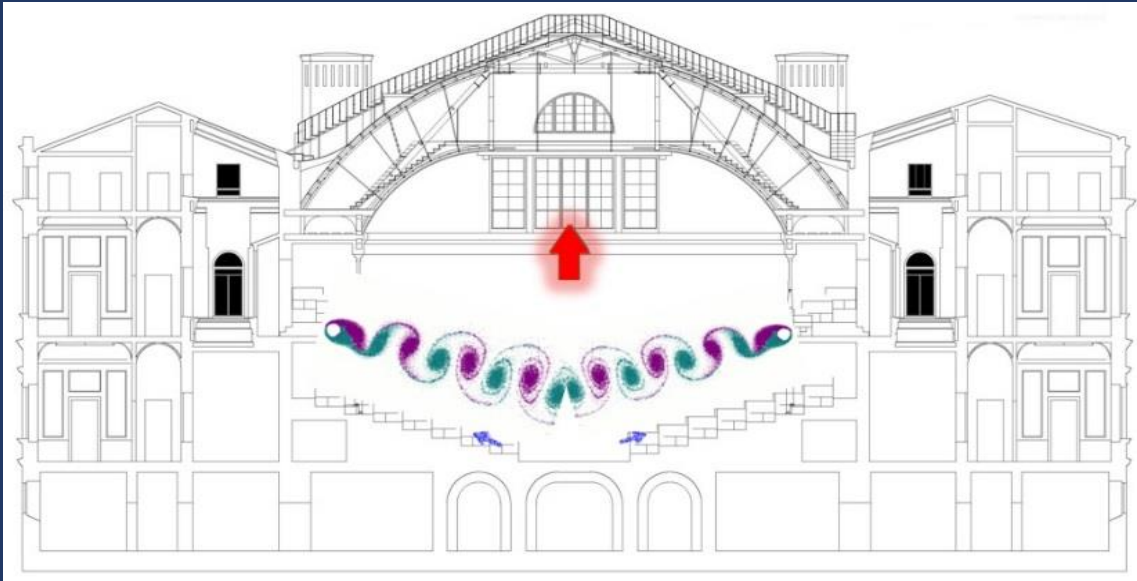

Visualization of the on-site smoke test. Its pattern is very similar to the results produced by PHOENICS/Flair.

Conclusion - The ventilation system works well as a displacement system in the “Galeria” and a mixing system in the rear seating area beneath it. This provides excellent heat extraction.

In the main semicircular “Hemiciclo” area, the jets from the whirl diffusers do not penetrate sufficiently to cause draughts; air velocities remain low on all seats. Increased air velocity, observed in the central part of the chamber, is caused by buoyancy from the thermal load.

The area beneath the Galeria, i.e. at the rear of the main seating, may reach a temperature of 28°C under extreme load conditions (600 persons + computers). The air flow rate is sufficient to cover the heat load of about 250 persons beneath the Galeria. See full text as a CHAM Case Study [here](#)



www.tayra.es



www.krantz.de

News from CHAM Agents



A PHOENICS User Meeting was held in Shanghai recently by our agent, Shanghai Feiyi. The first photo shows ex-CHAM Director, Dr Jeremy Wu, lecturing to the assembly about PHOENICS-2019; the second shows attendees.



News from CHAM

Looking for a challenging job as a CAD and GUI Software Development Engineer in a small company that believes in its people and places great importance on the calibre of its staff? CHAM has an opening in its London Office in Wimbledon Village.

CHAM is seeking an Engineer with strong knowledge of, and interest in, Computer Aided Design, Graphical User Interface design and graphical display to join its Wimbledon-based team.

The main task is assisting the Software Development Team to develop, implement, test and document user interface design, graphical display, CAD elements and CAD-to-CFD interfaces for PHOENICS (the most established independent CFD software available) and other CHAM products.

The successful candidate will be also be able to work with CHAM colleagues on Product Development, User Support and Consultancy as required thus being involved in a broad range of activities.

For further information on the role, and on where to send your CV, please go to www.cham.co.uk/careers.

Dr Timothy Brauner, of CHAM, will attend the WindSim User Meeting in Norway June 5 – 6 2019.

Should you require any further information on any of our offered products or services, please give us a call on +44 (20) 8947 7651. Alternatively, you can email us on sales@CHAM.co.uk

Our website can be viewed at www.CHAM.co.uk and we are on the following social media:

